

Supplies Usage

Supplies ordering information is located at www.xerox.com/office/supplies

Consumables

1 Toner Cartridges



Black

Date Installed: Sep 2, 2022
 Reorder: 006R01742
 Estimated Pages Remaining: 500
 (Based upon this toner cartridge's average coverage: 4%)

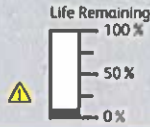

Cyan

Date Installed: Mar 28, 2023
 Reorder: 006R01743
 Estimated Pages Remaining: 17000
 (Based upon this toner cartridge's average coverage: 5%)

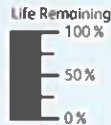

Magenta

Date Installed: Mar 28, 2023
 Reorder: 006R01744
 Estimated Pages Remaining: 16500
 (Based upon this toner cartridge's average coverage: 6%)

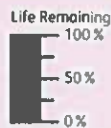

Yellow

Date Installed: Mar 28, 2023
 Reorder: 006R01745
 Estimated Pages Remaining: 16500
 (Based upon this toner cartridge's average coverage: 7%)

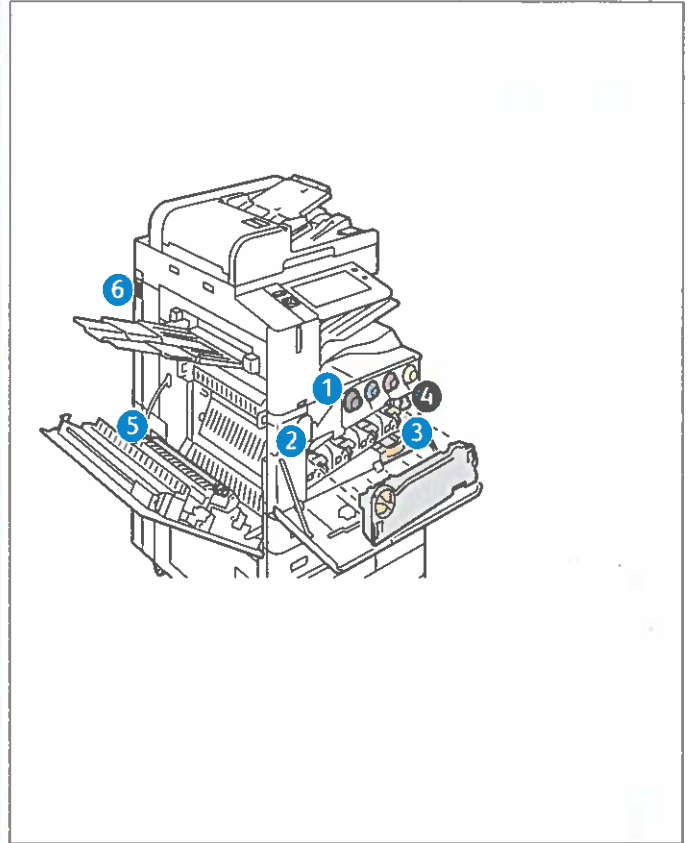

Routine Maintenance Items

2 Drum Cartridge



Black (R1)

Date Installed: Nov 15, 2022
 Reorder: 013R00681
 Estimated Pages Remaining: 177500
 (Based on average printer job size: 1 Pages)

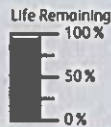

Cyan (R2)

Date Installed: Nov 15, 2022
 Reorder: 013R00681
 Estimated Pages Remaining: 162000
 (Based on average printer job size: 1 Pages)

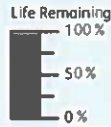

Magenta (R3)

Date Installed: Nov 15, 2022
 Reorder: 013R00681
 Estimated Pages Remaining: 162000
 (Based on average printer job size: 1 Pages)



Yellow (R4)

Date Installed: Nov 15, 2022
 Reorder: 013R00681
 Estimated Pages Remaining: 162000
 (Based on average printer job size: 1 Pages)



3 Waste Container

Date Installed: Mar 22, 2023
 Reorder: 008R08101

OK



4 Transfer Belt Cleaner

Date Installed: Mar 22, 2023
 Reorder: 001R00623
 Estimated Pages Remaining: 150500

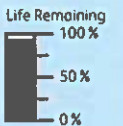

5 Second Bias Transfer Roller

Date Installed: Mar 22, 2023
 Reorder: 008R08103
 Estimated Pages Remaining: 350500

