

Využití spotřebního materiálu

Informace o objednání spotřebního materiálu naleznete na adrese
www.xerox.com/office/supplies

Spotřební materiál

1 Kazety s tonerem



Černá

Datum instalace: Jan 9, 2021
 Objednat: 006R01754
 Odhadovaný zbývající počet stran: 35500
 (Podle průměrného pokrytí této kazety s tonerem: 60%)



Azurová

Datum instalace: Jan 9, 2021
 Objednat: 006R01755
 Odhadovaný zbývající počet stran: 21000
 (Podle průměrného pokrytí této kazety s tonerem: 2%)

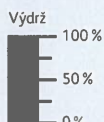

Purpurová

Datum instalace: Jan 9, 2021
 Objednat: 006R01756
 Odhadovaný zbývající počet stran: 21000
 (Podle průměrného pokrytí této kazety s tonerem: 0%)



Žlutá

Datum instalace: Jan 9, 2021
 Objednat: 006R01757
 Odhadovaný zbývající počet stran: 21000
 (Podle průměrného pokrytí této kazety s tonerem: 0%)

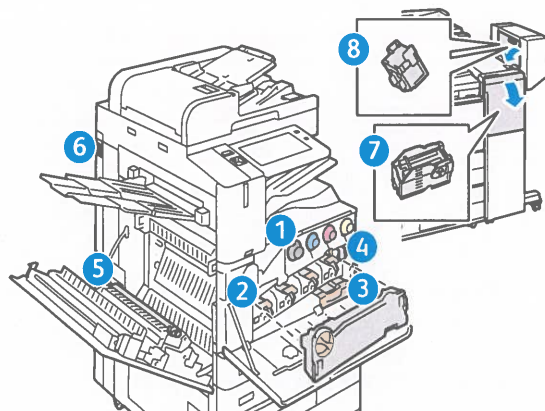

Položky běžné údržby

2 Tisková jednotka



Černá (R1)

Datum instalace: Sep 19, 2022
 Objednat: 013R00681
 Odhadovaný zbývající počet stran: 64000
 (Podle průměrné velikosti tiskové úlohy: 1 Strany)

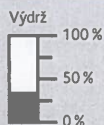

Azurová (R2)

Datum instalace: Sep 19, 2022
 Objednat: 013R00681
 Odhadovaný zbývající počet stran: 61000
 (Podle průměrné velikosti tiskové úlohy: 1 Strany)



Purpurová (R3)

Datum instalace: Feb 17, 2023
 Objednat: 013R00681
 Odhadovaný zbývající počet stran: 118500
 (Podle průměrné velikosti tiskové úlohy: 1 Strany)

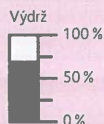

Žlutá (R4)

Datum instalace: Nov 29, 2021
 Objednat: 013R00681
 Odhadovaný zbývající počet stran: 32000
 (Podle průměrné velikosti tiskové úlohy: 1 Strany)



3 Odpadní nádobka

Datum instalace: Jan 1, 2021
 Objednat: 008R08101

OK

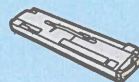

4 Čistič přenosového pásu

Datum instalace: Jan 1, 2021
 Objednat: 001R00623
 Odhadovaný zbývající počet stran: 259500

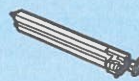
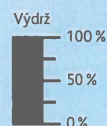

5 Druhý přenosový váleček

Datum instalace: Jan 1, 2021
 Objednat: 008R08103
 Odhadovaný zbývající počet stran: 359500

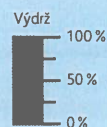

Informace o recyklaci naleznete na adrese:
www.xerox.com/gwa

Sarf Malzemesi Kullanımı

Sarf malzemesi sipariş bilgisi konumu:
www.xerox.com/office/supplies

Sarf Malzemeleri

1 Toner Kartuşları

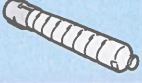

Siyah

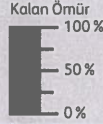
Takıldığı Tarih: Jan 9, 2021
Yeniden sipariş et: 006R01754
Tahmini Kalan Sayfa: 35500
(Bu toner kartuşunun ortalama kapasitesine göre: 59%)

Cam Göbeği

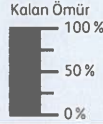
Takıldığı Tarih: Jan 9, 2021
Yeniden sipariş et: 006R01755
Tahmini Kalan Sayfa: 21000
(Bu toner kartuşunun ortalama kapasitesine göre: 2%)

Macenta

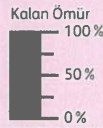
Takıldığı Tarih: Jan 9, 2021
Yeniden sipariş et: 006R01756
Tahmini Kalan Sayfa: 21000
(Bu toner kartuşunun ortalama kapasitesine göre: 0%)

Sarı

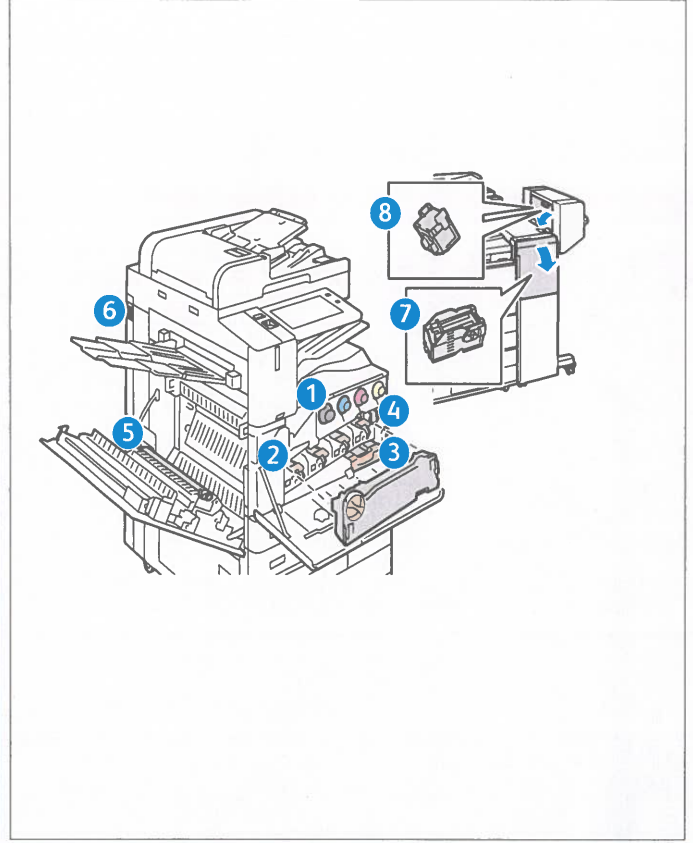
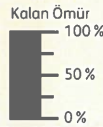
Takıldığı Tarih: Jan 9, 2021
Yeniden sipariş et: 006R01757
Tahmini Kalan Sayfa: 21000
(Bu toner kartuşunun ortalama kapasitesine göre: 0%)

Rutin Bakım Öğeleri

2 Tambur Kartuşu

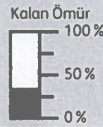
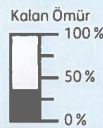
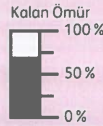
Siyah
(R1)Takıldığı Tarih: Sep 19, 2022
Yeniden sipariş et: 013R00681
Tahmini Kalan Sayfa: 64000
(Ortalama yazıcı iş boyutuna göre: 1 Sayfa Sayısı)Cam Göbeği
(R2)Takıldığı Tarih: Sep 19, 2022
Yeniden sipariş et: 013R00681
Tahmini Kalan Sayfa: 61000
(Ortalama yazıcı iş boyutuna göre: 1 Sayfa Sayısı)Macenta
(R3)Takıldığı Tarih: Feb 17, 2023
Yeniden sipariş et: 013R00681
Tahmini Kalan Sayfa: 118500
(Ortalama yazıcı iş boyutuna göre: 1 Sayfa Sayısı)Sarı
(R4)Takıldığı Tarih: Nov 29, 2021
Yeniden sipariş et: 013R00681
Tahmini Kalan Sayfa: 32000
(Ortalama yazıcı iş boyutuna göre: 1 Sayfa Sayısı)

3 Atık Kabı

Takıldığı Tarih: Jan 1, 2021
Yeniden sipariş et: 008R08101

Tamam

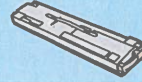

4 Aktarım Şeridi Temizleyicisi

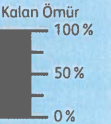
Takıldığı Tarih: Jan 1, 2021
Yeniden sipariş et: 001R00623
Tahmini Kalan Sayfa: 259500

5 İkinci Eğilimli Aktarım Silindiri

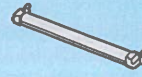
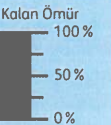
Takıldığı Tarih: Jan 1, 2021
Yeniden sipariş et: 008R08103
Tahmini Kalan Sayfa: 359500

Zużycie materiałów eksploatacyjnych

Informacje o zamawianiu materiałów eksploatacyjnych:
www.xerox.com/office/supplies

Materiały eksploatacyjne

1 Wkłady z tonerem



Czarny

Data instalacji: Jan 9, 2021
 Zamów: 006R01754
 Szacowana liczba pozostałych stron: 35500
 (W oparciu o średnie pokrycie z tego pojemnika toneru: 59%)

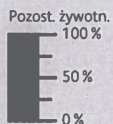

Niebiesko-zielony

Data instalacji: Jan 9, 2021
 Zamów: 006R01755
 Szacowana liczba pozostałych stron: 21000
 (W oparciu o średnie pokrycie z tego pojemnika toneru: 2%)



Magenta

Data instalacji: Jan 9, 2021
 Zamów: 006R01756
 Szacowana liczba pozostałych stron: 21000
 (W oparciu o średnie pokrycie z tego pojemnika toneru: 0%)



Żółty

Data instalacji: Jan 9, 2021
 Zamów: 006R01757
 Szacowana liczba pozostałych stron: 21000
 (W oparciu o średnie pokrycie z tego pojemnika toneru: 0%)

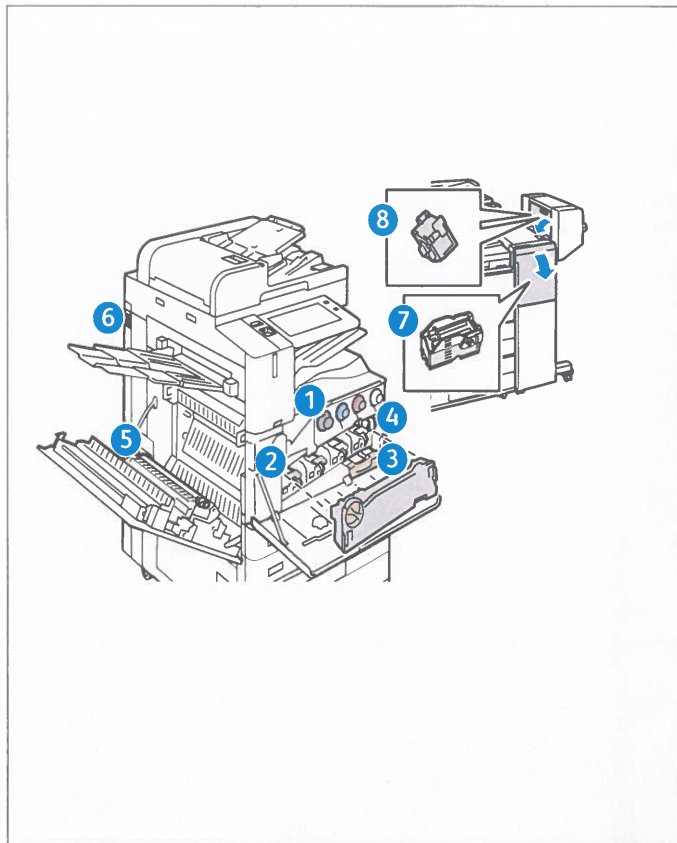

Elementy rutynowej konserwacji

2 Wkład bębna

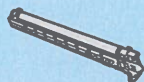

Czarny (R1)

Data instalacji: Sep 19, 2022
 Zamów: 013R00681
 Szacowana liczba pozostałych stron: 64000
 (W oparciu o średni rozmiar pracy drukowania: 1 Str.)

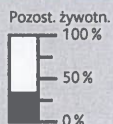

Niebiesko-zielony (R2)

Data instalacji: Sep 19, 2022
 Zamów: 013R00681
 Szacowana liczba pozostałych stron: 61000
 (W oparciu o średni rozmiar pracy drukowania: 1 Str.)



Magenta (R3)

Data instalacji: Feb 17, 2023
 Zamów: 013R00681
 Szacowana liczba pozostałych stron: 118500
 (W oparciu o średni rozmiar pracy drukowania: 1 Str.)



Żółty (R4)

Data instalacji: Nov 29, 2021
 Zamów: 013R00681
 Szacowana liczba pozostałych stron: 32000
 (W oparciu o średni rozmiar pracy drukowania: 1 Str.)



3 Pojemnik na odpady

Data instalacji: Jan 1, 2021
 Zamów: 008R08101

OK



4 Środek czyszczący taśmy transferowej

Data instalacji: Jan 1, 2021
 Zamów: 001R00623
 Szacowana liczba pozostałych stron: 259500

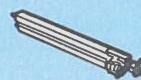
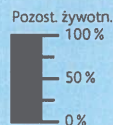

5 Druga rolka taśmy transferowej polaryzacji

Data instalacji: Jan 1, 2021
 Zamów: 008R08103
 Szacowana liczba pozostałych stron: 359500

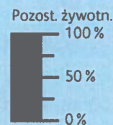

Utilizare consumabile

Informațiile pentru comenzile de consumabile se află la www.xerox.com/office/supplies

Consumabile

1 Cartușe cu toner



Negru

Data instalării: Jan 9, 2021
Comandă: 006R01754
Nr. estimat de pagini rămase: 35500
(La acoperirea medie realizată cu acest cartuș cu toner: 58%)



Cyan

Data instalării: Jan 9, 2021
Comandă: 006R01755
Nr. estimat de pagini rămase: 21000
(La acoperirea medie realizată cu acest cartuș cu toner: 2%)



Magenta

Data instalării: Jan 9, 2021
Comandă: 006R01756
Nr. estimat de pagini rămase: 21000
(La acoperirea medie realizată cu acest cartuș cu toner: 0%)



Galben

Data instalării: Jan 9, 2021
Comandă: 006R01757
Nr. estimat de pagini rămase: 21000
(La acoperirea medie realizată cu acest cartuș cu toner: 1%)

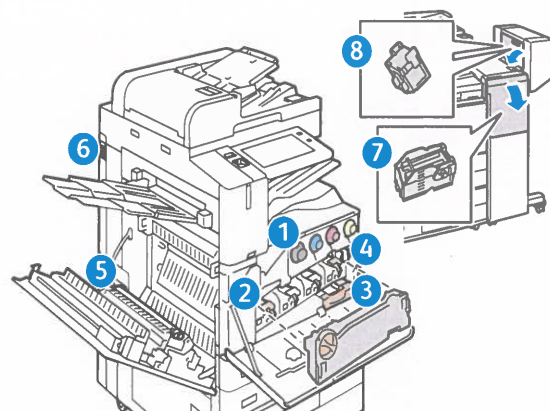

Articole pentru întreținere curentă

2 Cartuș cilindru



Negru (R1)

Data instalării: Sep 19, 2022
Comandă: 013R00681
Nr. estimat de pagini rămase: 64000
(Cu lucrări de imprimare de dimensiune medie: 1 Pagini)



Cyan (R2)

Data instalării: Sep 19, 2022
Comandă: 013R00681
Nr. estimat de pagini rămase: 61000
(Cu lucrări de imprimare de dimensiune medie: 1 Pagini)



Magenta (R3)

Data instalării: Feb 17, 2023
Comandă: 013R00681
Nr. estimat de pagini rămase: 118500
(Cu lucrări de imprimare de dimensiune medie: 1 Pagini)



Galben (R4)

Data instalării: Nov 29, 2021
Comandă: 013R00681
Nr. estimat de pagini rămase: 32000
(Cu lucrări de imprimare de dimensiune medie: 1 Pagini)



3 Recipient pentru reziduuri

Data instalării: Jan 1, 2021
Comandă: 008R08101

OK

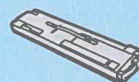

4 Dispozitivul de curățare a benzii de transfer

Data instalării: Jan 1, 2021
Comandă: 001R00623
Nr. estimat de pagini rămase: 259500

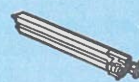

5 Rolă de transfer

Data instalării: Jan 1, 2021
Comandă: 008R08103
Nr. estimat de pagini rămase: 359500



Χρήση αναλωσίμων

Αναλώσιμα

1 Κασέτες γραφίτη

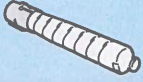

Μαύρο

Θμ/νία εγκατάστ.: Jan 9, 2021
Εκ νέου παραγγελία: 006R01754
Εκτιμώμενος αρ. υπολειπ. σελίδων: 35500
(Βάσει της μέσης κάλυψης αυτής της κασέτας γραφίτη: 58 %)

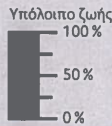

Κυανό

Θμ/νία εγκατάστ.: Jan 9, 2021
Εκ νέου παραγγελία: 006R01755
Εκτιμώμενος αρ. υπολειπ. σελίδων: 21000
(Βάσει της μέσης κάλυψης αυτής της κασέτας γραφίτη: 2 %)

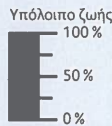

Ματζέντα

Θμ/νία εγκατάστ.: Jan 9, 2021
Εκ νέου παραγγελία: 006R01756
Εκτιμώμενος αρ. υπολειπ. σελίδων: 21000
(Βάσει της μέσης κάλυψης αυτής της κασέτας γραφίτη: 0 %)

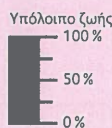

Κίτρινο

Θμ/νία εγκατάστ.: Jan 9, 2021
Εκ νέου παραγγελία: 006R01757
Εκτιμώμενος αρ. υπολειπ. σελίδων: 21000
(Βάσει της μέσης κάλυψης αυτής της κασέτας γραφίτη: 1 %)

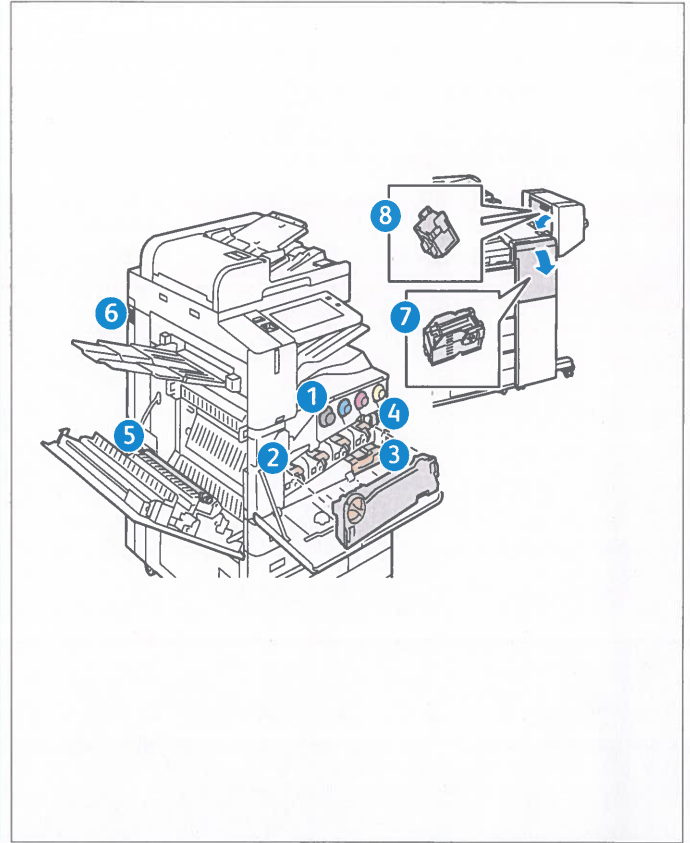
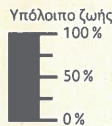

Στοιχεία προγραμματισμένης συντήρησης

2 Φύσιγγα τυμπάνου

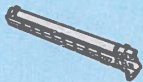

Μαύρο (R1)

Θμ/νία εγκατάστ.: Sep 19, 2022
Εκ νέου παραγγελία: 013R00681
Εκτιμώμενος αρ. υπολειπ. σελίδων: 64000
(Βάσει του μέσου μεγέθους εργασιών του εκτυπωτή: 1 Σελίδες)

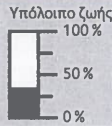

Κυανό (R2)

Θμ/νία εγκατάστ.: Sep 19, 2022
Εκ νέου παραγγελία: 013R00681
Εκτιμώμενος αρ. υπολειπ. σελίδων: 61000
(Βάσει του μέσου μεγέθους εργασιών του εκτυπωτή: 1 Σελίδες)

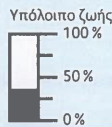

Ματζέντα (R3)

Θμ/νία εγκατάστ.: Feb 17, 2023
Εκ νέου παραγγελία: 013R00681
Εκτιμώμενος αρ. υπολειπ. σελίδων: 118500
(Βάσει του μέσου μεγέθους εργασιών του εκτυπωτή: 1 Σελίδες)

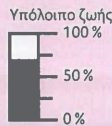

Κίτρινο (R4)

Θμ/νία εγκατάστ.: Nov 29, 2021
Εκ νέου παραγγελία: 013R00681
Εκτιμώμενος αρ. υπολειπ. σελίδων: 32000
(Βάσει του μέσου μεγέθους εργασιών του εκτυπωτή: 1 Σελίδες)



3 Περιέκτης υπολειμμάτων

Θμ/νία εγκατάστ.: Jan 1, 2021
Εκ νέου παραγγελία: 008R08101

OK

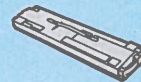

4 Σύστημα καθαρισμού ιμάντα μεταφοράς

Θμ/νία εγκατάστ.: Jan 1, 2021
Εκ νέου παραγγελία: 001R00623
Εκτιμώμενος αρ. υπολειπ. σελίδων: 259500



5 Δεύτερος κύλινδρος μεταφοράς φόρτισης

Θμ/νία εγκατάστ.: Jan 1, 2021
Εκ νέου παραγγελία: 008R08103
Εκτιμώμενος αρ. υπολειπ. σελίδων: 359500



Kellékfelhasználás

Fogyóanyagok

1 Festékkazetták

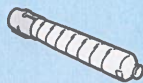

Fekete

Üzembe helyezés dátuma: Jan 9, 2021
Utánrendelés: 006R01754
Becsült fennmaradó oldalszám: 35500
(A festékkazetta átlagos fedettségét alapul véve.: 57%)

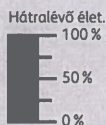

Ciánkék

Üzembe helyezés dátuma: Jan 9, 2021
Utánrendelés: 006R01755
Becsült fennmaradó oldalszám: 21000
(A festékkazetta átlagos fedettségét alapul véve.: 2%)



Bíbor

Üzembe helyezés dátuma: Jan 9, 2021
Utánrendelés: 006R01756
Becsült fennmaradó oldalszám: 21000
(A festékkazetta átlagos fedettségét alapul véve.: 0%)



Sárga

Üzembe helyezés dátuma: Jan 9, 2021
Utánrendelés: 006R01757
Becsült fennmaradó oldalszám: 21000
(A festékkazetta átlagos fedettségét alapul véve.: 1%)

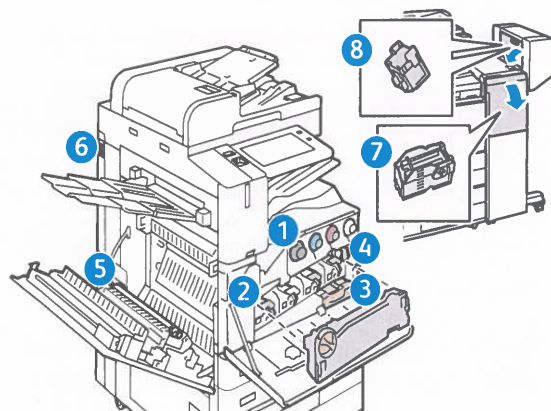

Rutin karbantartási elemek

2 Dobkazetta

Fekete
(R1)

Üzembe helyezés dátuma: Sep 19, 2022
Utánrendelés: 013R00681
Becsült fennmaradó oldalszám: 64000
(Nyomtató átlagos munkamérete alapján: 1 Oldalak)

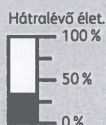
Ciánkék
(R2)

Üzembe helyezés dátuma: Sep 19, 2022
Utánrendelés: 013R00681
Becsült fennmaradó oldalszám: 61000
(Nyomtató átlagos munkamérete alapján: 1 Oldalak)

Bíbor
(R3)

Üzembe helyezés dátuma: Feb 17, 2023
Utánrendelés: 013R00681
Becsült fennmaradó oldalszám: 118500
(Nyomtató átlagos munkamérete alapján: 1 Oldalak)

Sárga
(R4)

Üzembe helyezés dátuma: Nov 29, 2021
Utánrendelés: 013R00681
Becsült fennmaradó oldalszám: 32000
(Nyomtató átlagos munkamérete alapján: 1 Oldalak)



3 Hulladéktartály

Üzembe helyezés dátuma: Jan 1, 2021
Utánrendelés: 008R08101

OK

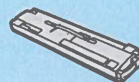

4 Továbbító szij tisztítóegysége

Üzembe helyezés dátuma: Jan 1, 2021
Utánrendelés: 001R00623
Becsült fennmaradó oldalszám: 259500



5 Második színátvivő henger

Üzembe helyezés dátuma: Jan 1, 2021
Utánrendelés: 008R08103
Becsült fennmaradó oldalszám: 359500

