

Supplies Usage

Supplies ordering information is located at www.xerox.com/office/supplies

Consumables

1 Toner Cartridges



Black	Date Installed: Jan 9, 2021 Reorder: 006R01754 Estimated Pages Remaining: 35500 (Based upon this toner cartridge's average coverage: 52%)	Life Remaining 100% 50% 0%
Cyan	Date Installed: Jan 9, 2021 Reorder: 006R01755 Estimated Pages Remaining: 21000 (Based upon this toner cartridge's average coverage: 3%)	Life Remaining 100% 50% 0%
Magenta	Date Installed: Jan 9, 2021 Reorder: 006R01756 Estimated Pages Remaining: 21000 (Based upon this toner cartridge's average coverage: 0%)	Life Remaining 100% 50% 0%
Yellow	Date Installed: Jan 9, 2021 Reorder: 006R01757 Estimated Pages Remaining: 21000 (Based upon this toner cartridge's average coverage: 1%)	Life Remaining 100% 50% 0%

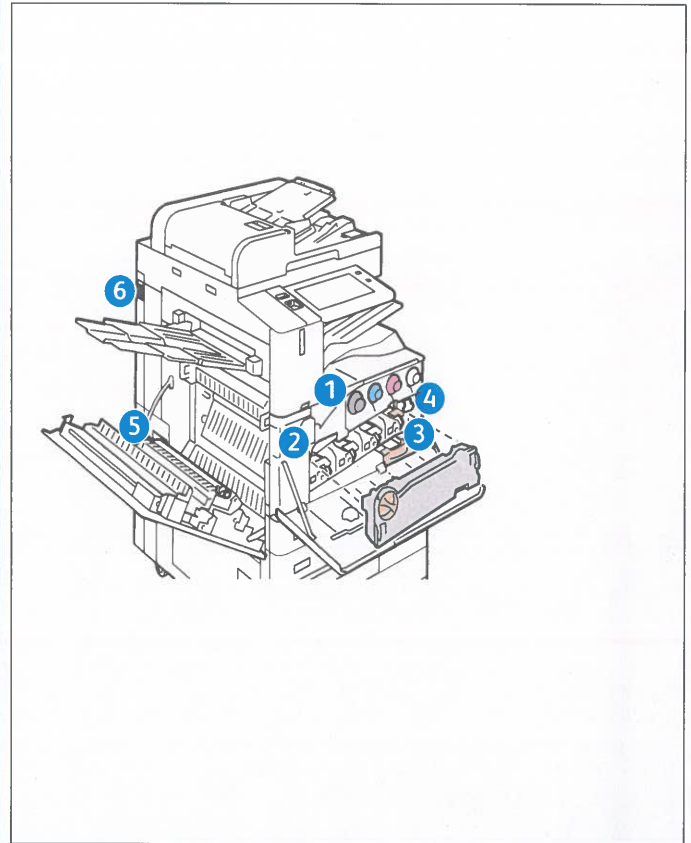

Routine Maintenance Items

2 Drum Cartridge

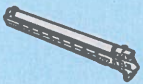

Black (R1)	Date Installed: Sep 19, 2022 Reorder: 013R00681 Estimated Pages Remaining: 62000 (Based on average printer job size: 1 Pages)	Life Remaining 100% 50% 0%
Cyan (R2)	Date Installed: Sep 19, 2022 Reorder: 013R00681 Estimated Pages Remaining: 61000 (Based on average printer job size: 1 Pages)	Life Remaining 100% 50% 0%
Magenta (R3)	Date Installed: Feb 17, 2023 Reorder: 013R00681 Estimated Pages Remaining: 118500 (Based on average printer job size: 1 Pages)	Life Remaining 100% 50% 0%
Yellow (R4)	Date Installed: Nov 29, 2021 Reorder: 013R00681 Estimated Pages Remaining: 32000 (Based on average printer job size: 1 Pages)	Life Remaining 100% 50% 0%

3 Waste Container

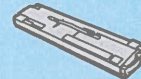

Date Installed: Jan 1, 2021
Reorder: 008R08101

OK

4 Transfer Belt Cleaner



Date Installed: Jan 1, 2021
Reorder: 001R00623
Estimated Pages Remaining: 259500

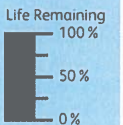

5 Second Bias Transfer Roller



Date Installed: Jan 1, 2021
Reorder: 008R08103
Estimated Pages Remaining: 359500

