

Xerox® AltaLink® B8245/B8255/B8270
Multifunction Printer

Control Panel

Available apps can vary based on your printer setup. For details about apps and features, refer to the *User Guide*.

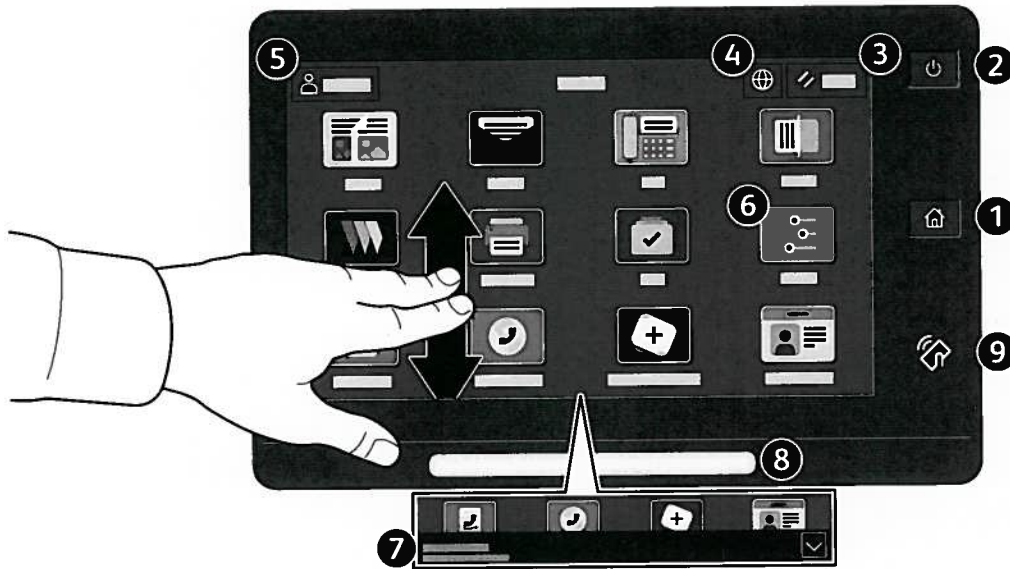

- 1 **Home** returns to the main app screen.
- 2 **Power/Wake** starts the printer or provides options to sleep, restart or power off the printer.
- 3 **Reset** restores settings to their default values in all apps.
- 4 **Language** provides choice of screen languages.
- 5 **Log In** provides special access to tools and settings.
- 6 **Device app** provides access to printer information and settings.
- 7 **Notification banner** shows printer status and warnings. To see all notifications, touch the banner. To close the banner, touch the down arrow.
- 8 **Status LED** indicates printer status. For detailed information, refer to the *User Guide*.
- 9 **NFC Area** allows pairing with a mobile device to print or scan from an app.

Device app

The Device app provides access to supplies status, printer information, and settings. Some menus and settings require log in with the administrator name and password.

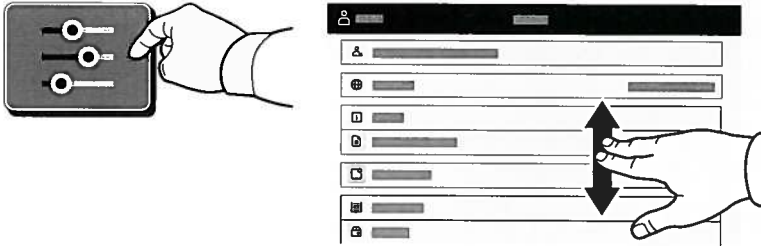

Billing and Usage Information

In the Device features menu, to view basic impression counts, touch **Billing/Usage**. To view detailed usage counts, touch **Usage Counters**. The list provides detailed impression count categories.



Embedded Web Server

The Xerox® Embedded Web Server enables you to access printer configuration details, paper and supplies status, job status, and diagnostic functions over a network. You can also manage fax, email, and address books.

To connect, in a Web browser, type the printer IP address. The network IPv4 address is available on the control panel touch screen. Touch **Device app** > **About**, then scroll down.

For details on using the Embedded Web Server, refer to the *User Guide* located on Xerox.com.

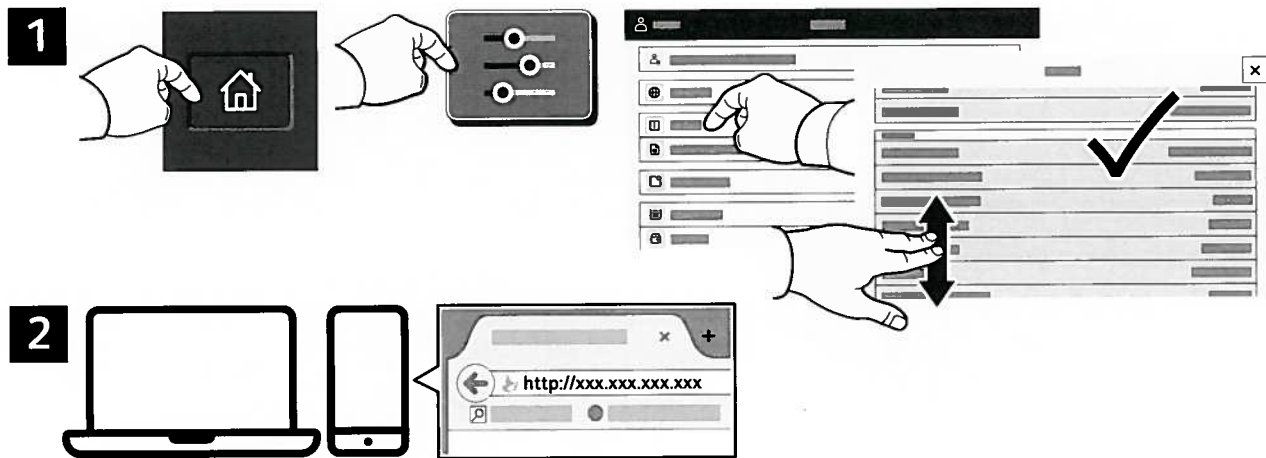

App Gallery

The Xerox App Gallery has a growing collection of productivity apps that you can install on your printer. Find the app on your home screen and create your login directly, or go to www.xerox.com/appgallery to log in and add your device. To simplify app installation, use the same name for your app gallery login credentials that you used for the printer login.

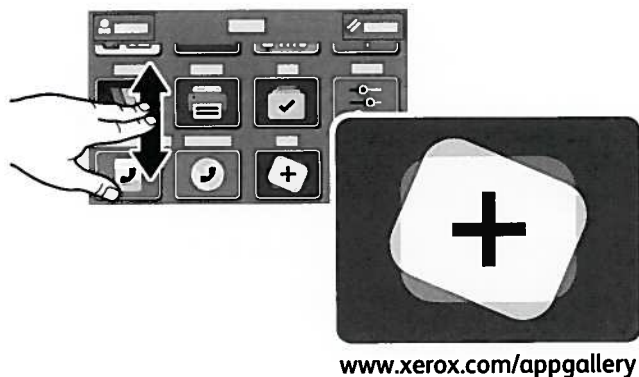

Printer Tour

Optional accessories can be part of your printer setup. For details, refer to the *User Guide*.

Single-Pass Duplex Automatic Document Feeder (DADF)

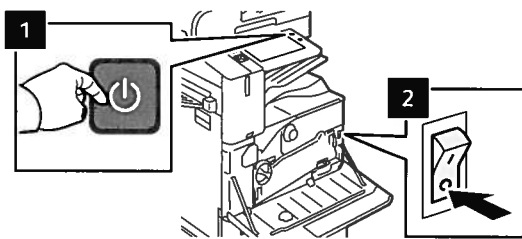
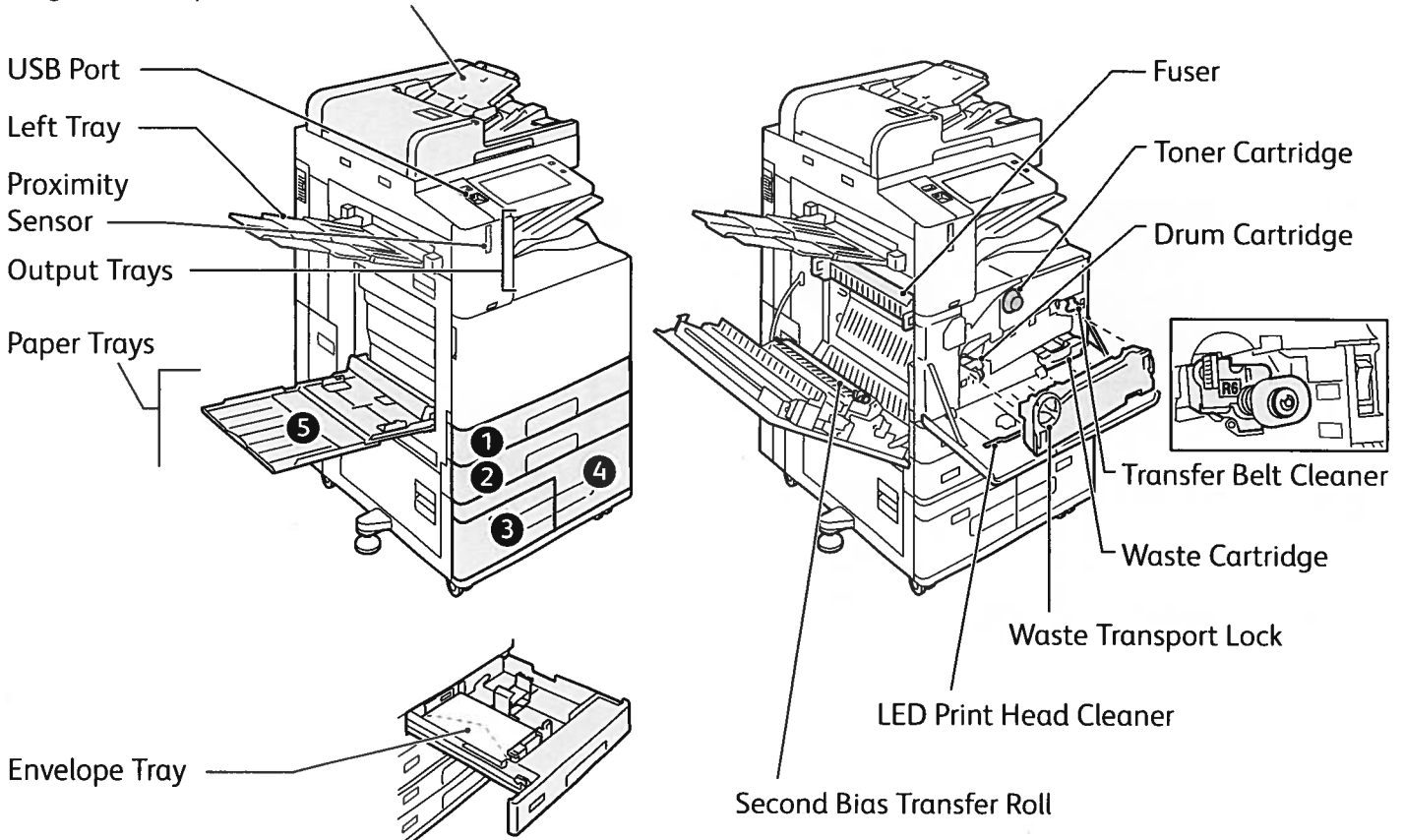

To restart the printer, on the control panel, press the **secondary power switch** (1).

For full printer power off, press the **secondary power switch** (1). Behind the front cover, press the **main power switch** (2).

To select sleep mode, press the **secondary power switch** (1). At the printer control panel touch screen, touch a selection.

37576

Xerox® AltaLink® B8245/B8255/B8270
Multifunction Printer

xerox™

Paper Handling

For a complete list of paper that works with your printer, see the Recommended Media List at:

www.xerox.com/rmlna (U. S. and Canada)

www.xerox.com/rmleu (Europe)

For details about trays and paper, refer to the *User Guide*.

37577

Loading Paper

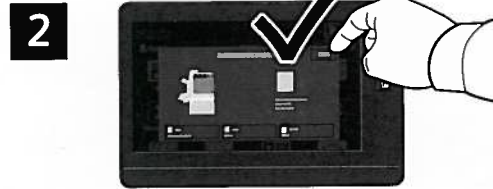
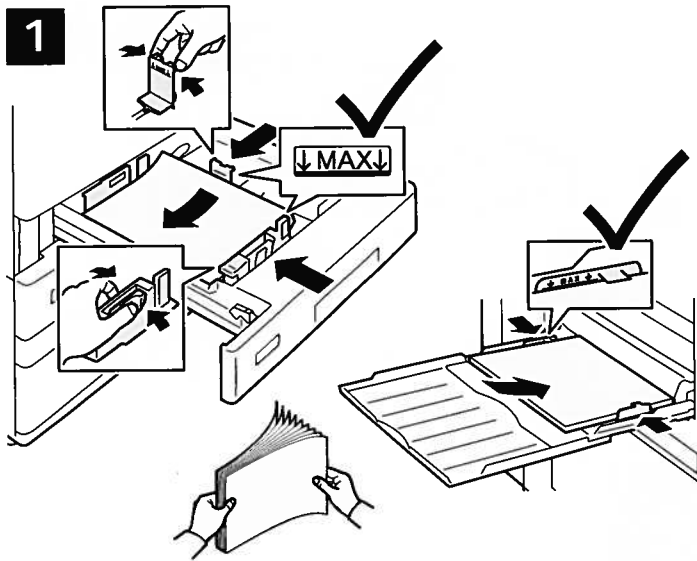

Confirm or change size, type, and color settings if needed.



For the best results, fan the edges of the paper. Adjust the guides to fit the paper size. Do not load paper above the maximum fill line.

When printing, select options in the print driver.

37578

Paper Orientation

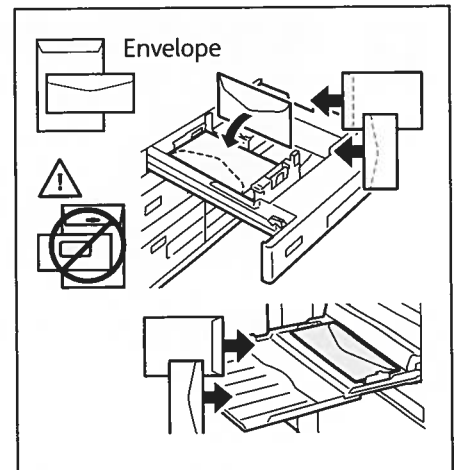
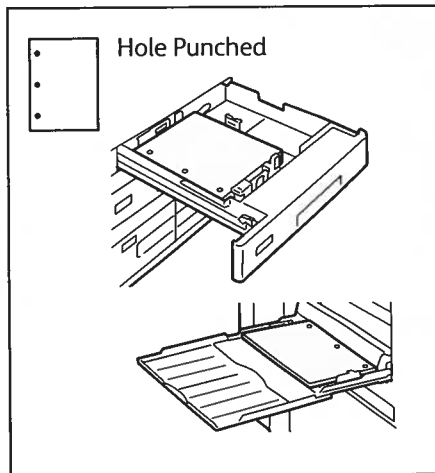
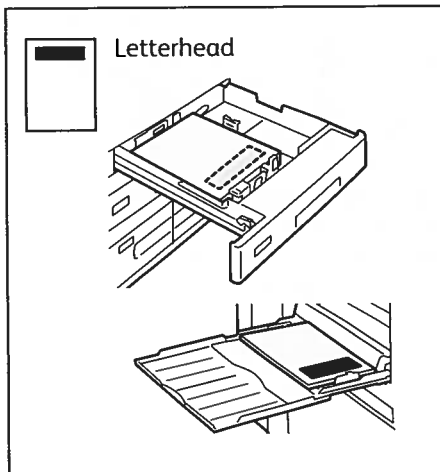

www.xerox.com/office/support

Copying

For details, refer to the *User Guide*.

1

X: 85–432 mm (3.3–17 in.)
Y: 125–297 mm (4.9–11.7 in.)

38–128 g/m²
(26 lb. Text–34 lb. Bond)

≤130 (80 g/m², 20 lb. Bond)
B8270: ≤250

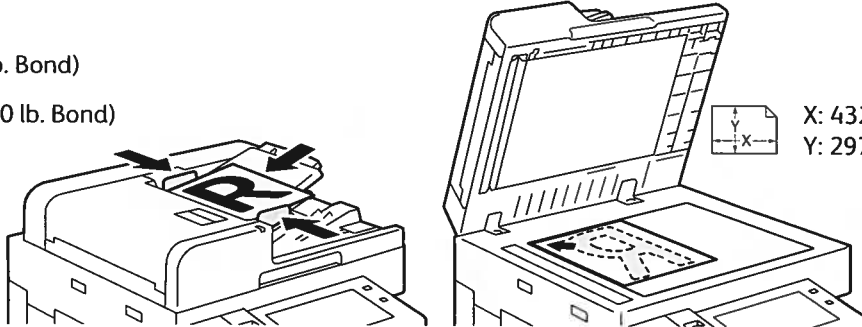

Load the original documents.

2



Touch **Copy**, then and select the number of copies.

3

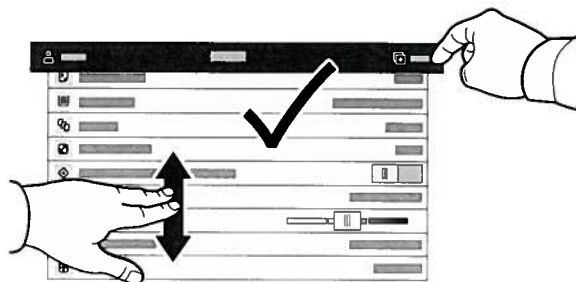

Select feature settings from the list, then touch **Start**.

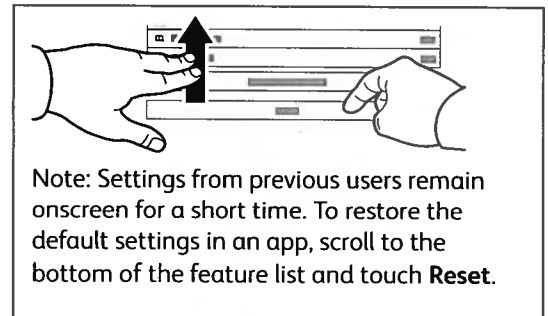

37580

Scanning and Emailing

If the printer is connected to a network, you can select a destination for the scanned image at the printer control panel.

This guide defines techniques to scan documents without preparing special setups:

- Scanning documents to an email address.
- Scanning documents to a saved Favorite, Address Book listing, or USB Flash Drive.
- Scanning documents to the Default Public folder on the printer hard drive, and retrieving them using your Web browser.

For details and more scan setups, refer to the *User Guide*. For details about address book and workflow template setup, refer to the *System Administrator Guide*.

1



X: 85–432 mm (3.3–17 in.)
Y: 125–297 mm (4.9–11.7 in.)



38–128 g/m²
(26 lb. Text–34 lb. Bond)



≤130 (80 g/m², 20 lb. Bond)
B8270: ≤250

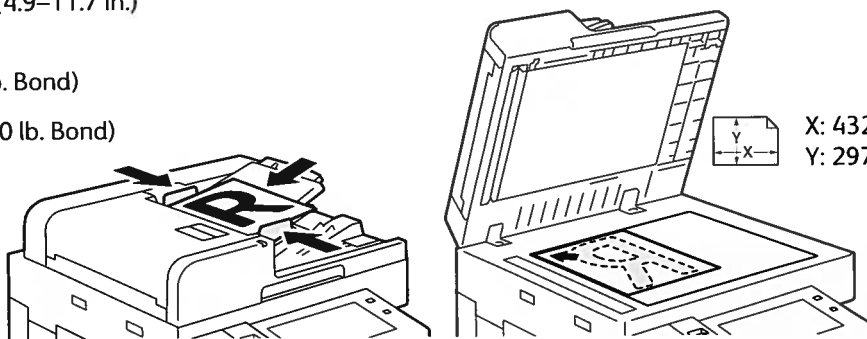
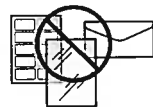

Load the original documents.

2



Press **Home**, then to email the scan, touch **Email**. To scan to the Default Public Folder or a USB Flash Drive, touch **Workflow Scanning**. If your scan destination is stored in the Address Book or saved as a Favorite, touch **Scan To**.



For Email, touch **Manual Entry**, type the email address using the touch screen keypad, then touch **Add**. To add more than one email address to the list, touch **Add Recipient**. To type a subject line for the email, touch **Subject**. To select saved email addresses, use the Device Address Book or select from Favorites.

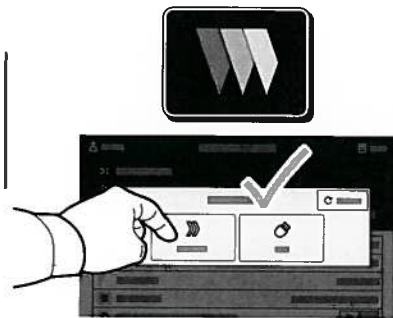

For Workflow Scanning, touch **Default Public Folder**, or insert your USB Flash Drive.

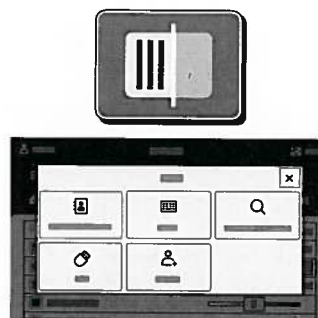
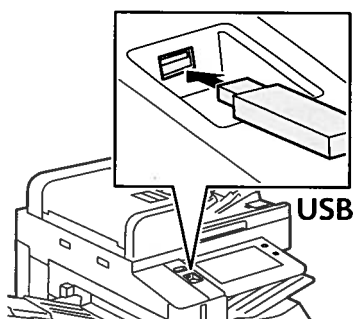

For Scan To, touch a destination type, then enter the appropriate information. To add more than one destination to the list, touch **Add Destination**.



Change the settings as needed, then touch **Scan**, or for Email, touch **Send**.

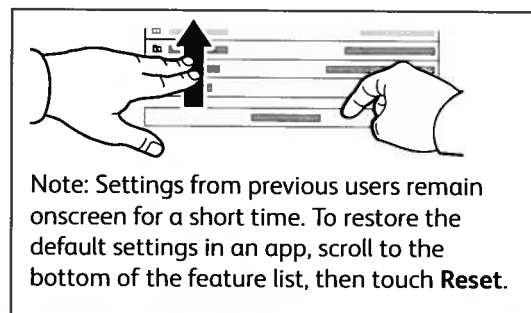

Note: Settings from previous users remain onscreen for a short time. To restore the default settings in an app, scroll to the bottom of the feature list, then touch **Reset**.

Retrieving Scan Files

To download your scanned images from the Default Public Folder on the printer, use the Embedded Web Server. You can set up personal folders and workflow scanning templates in the Embedded Web Server. For details, refer to the *User Guide*.

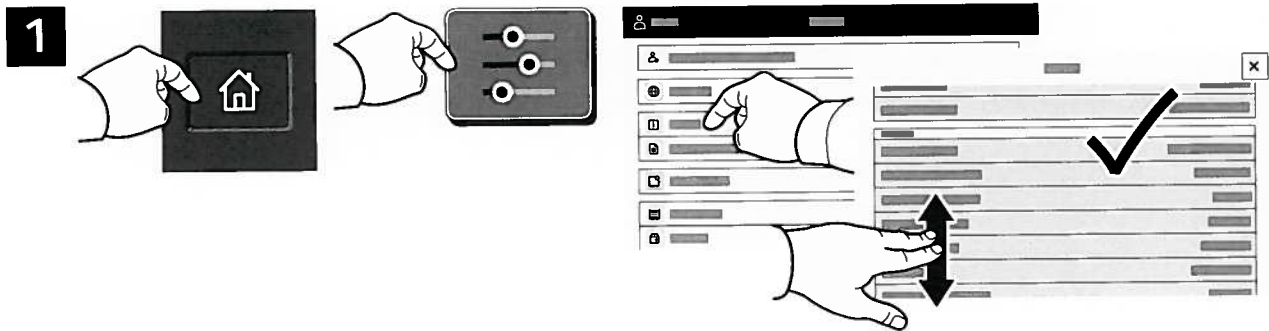

Note the printer IP address on the touch screen. If the IP Address does not appear in the top of the touch screen, press Home, touch **Device > About** then scroll to check the IP Address.

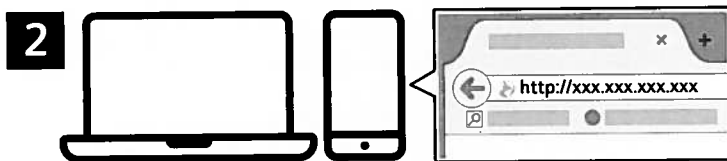

In a Web browser, type the printer IP address, then press **Enter** or **Return**.

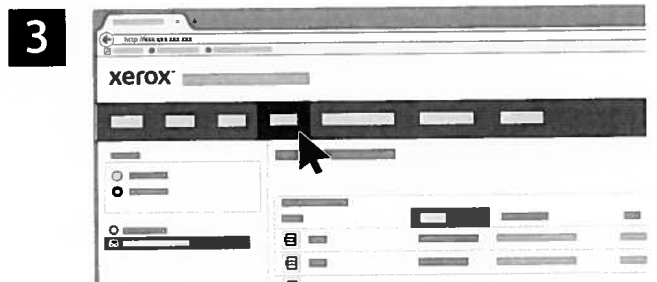

Click the **Scan** tab.

4

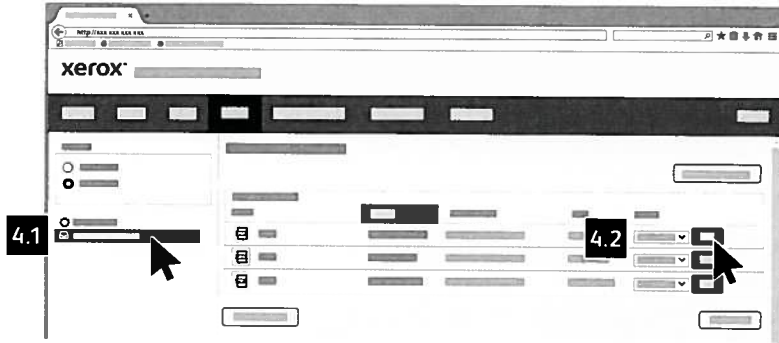

Select the **Default Public Folder**, then find your scan in the list. To download the scan, click **Go**.

To refresh the list, click **Update View**.

To save the file to your computer, select **Download**.

To print the saved file again, select **Reprint**.

To permanently remove the stored job, select **Delete**.

To open a directory, select **Open**.

Faxing

You can send a fax in one of four ways:

- **Fax** scans the document then sends it directly to a fax machine.
- **Server Fax** scans the document then sends it to a fax server, which transmits the document to a fax machine.
- **Internet Fax** scans the document then emails it to a recipient.
- **LAN Fax** sends the current print job as a fax.

For details, refer to the *User Guide*. For details about LAN Fax, refer to the print driver software. For details about fax setup and advanced settings, refer to the *System Administrator Guide*.

1



X: 85–432 mm (3.3–17 in.)
Y: 125–297 mm (4.9–11.7 in.)



38–128 g/m²
(26 lb. Text–34 lb. Bond)



≤130 (80 g/m², 20 lb. Bond)
B8270: ≤250

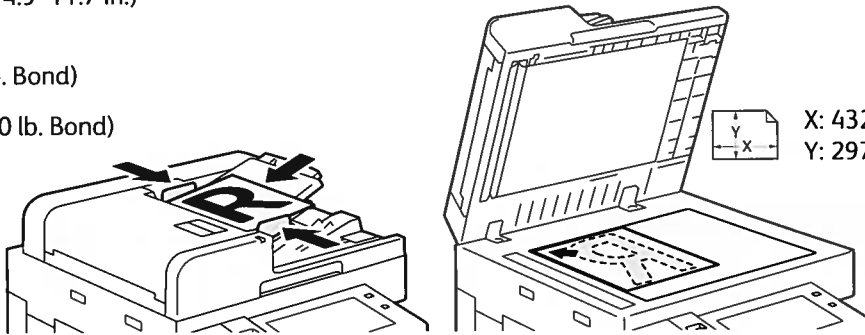
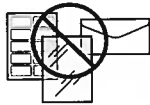

Load the original document.

2

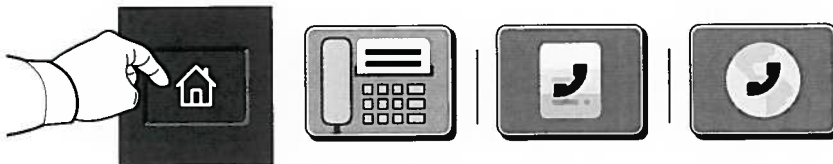

To send the fax to a fax machine, press **Home**, then touch **Fax** or **Server Fax**.

To send the fax as an email attachment, touch **Home**, then touch **Internet Fax**.

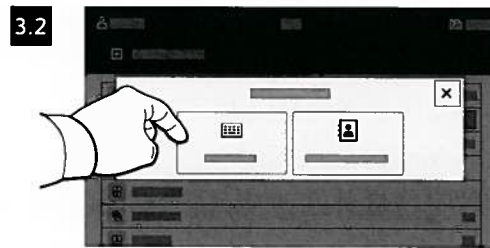
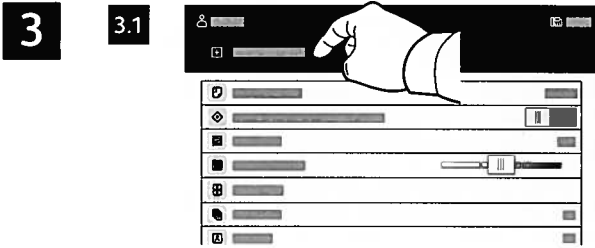

For fax numbers, touch **Manual Entry**, then enter the fax number using the touch screen alphanumeric keys and special characters. Touch **Add**. To add more fax numbers to the list, touch **Add Recipient**.

For Internet Fax email addresses, touch **Manual Entry**, then enter the email address using the touch screen keypad. Touch **Add**. To add more email addresses to the list, touch **Add Recipient**.

To select saved numbers, use the Device Address Book or Favorites. To select stored fax locations, use the Mailbox or Polling.

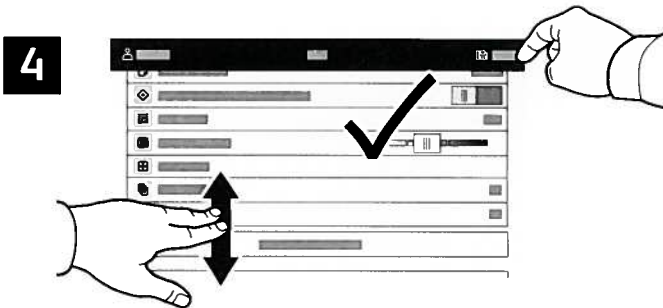

Change the settings as needed, then touch **Send**.

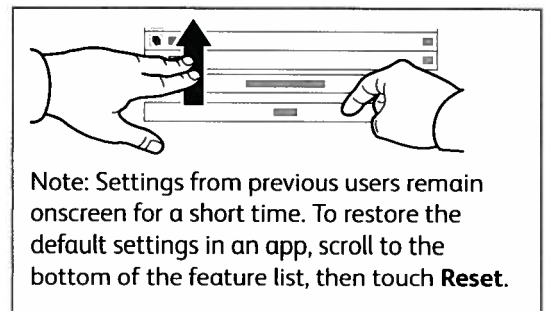

Printing from a USB Flash Drive

You can print .pdf, .tiff, .ps, .xps and other files types directly from a USB Flash Drive. For more information, refer to the *User Guide*.

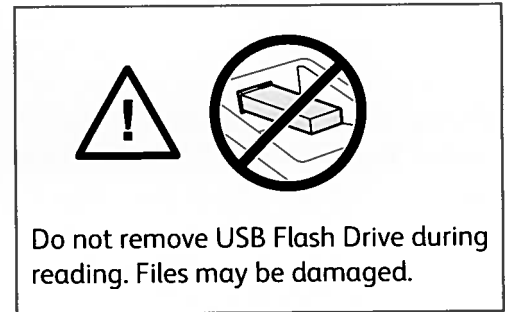
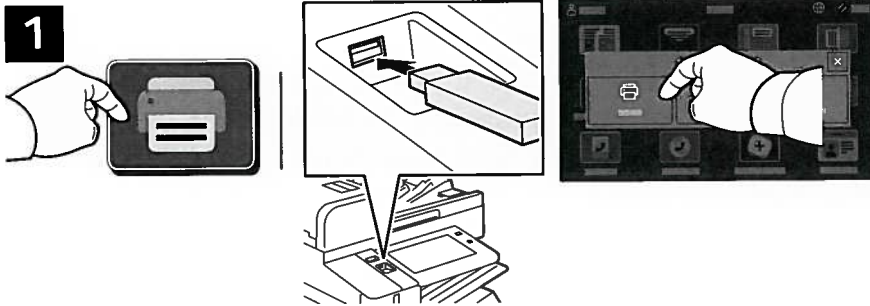

Touch **Print From** or insert your USB Flash Drive, then choose **Print From USB**.

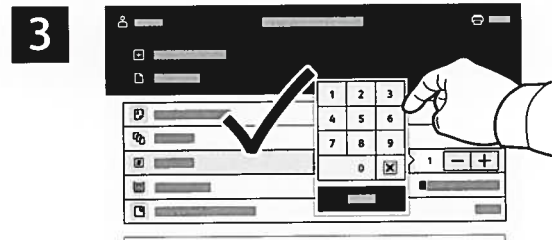
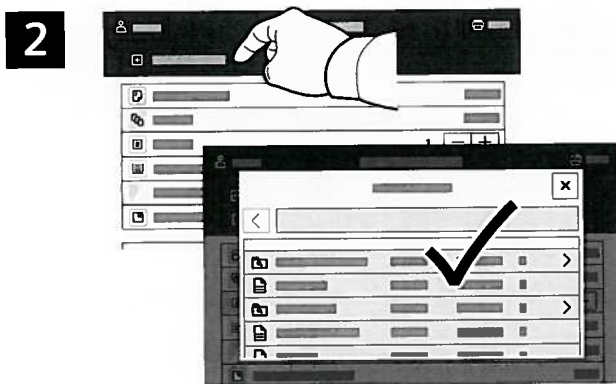

To select the number of copies, touch the plus sign (+) or the minus sign (-). For larger numbers, touch **Quantity** then enter a number.

Touch **Add Document**, then navigate to your files and select them.

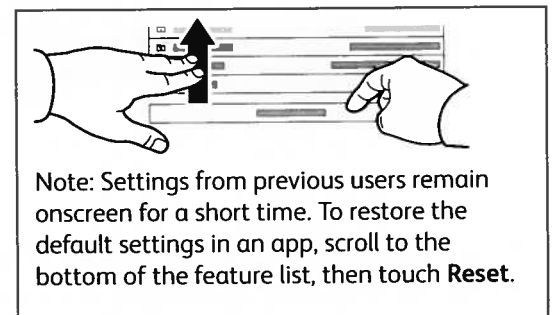

Select settings as needed, then touch **Print**.

Printing Jobs Stored on the Printer



You can send a print job to save to the printer, then select the job from the printer control panel to print at a later time. Jobs can be saved in the public folder or be password protected. In the Xerox® printer driver, select **Properties** (Windows) or **Xerox Features** (Mac OS), then **Job Type**. Select **Saved Job** or **Secure Print**. For Secure Print, type a passcode. Click **OK** and print the job.

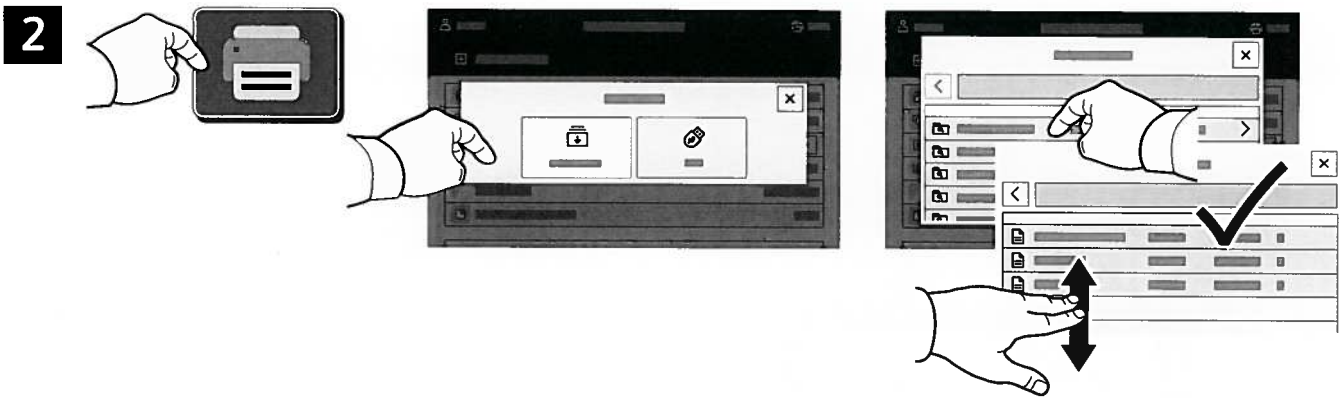

Touch **Print From** then touch **Saved Jobs**. Select the **Default Public Folder** then select your print job.

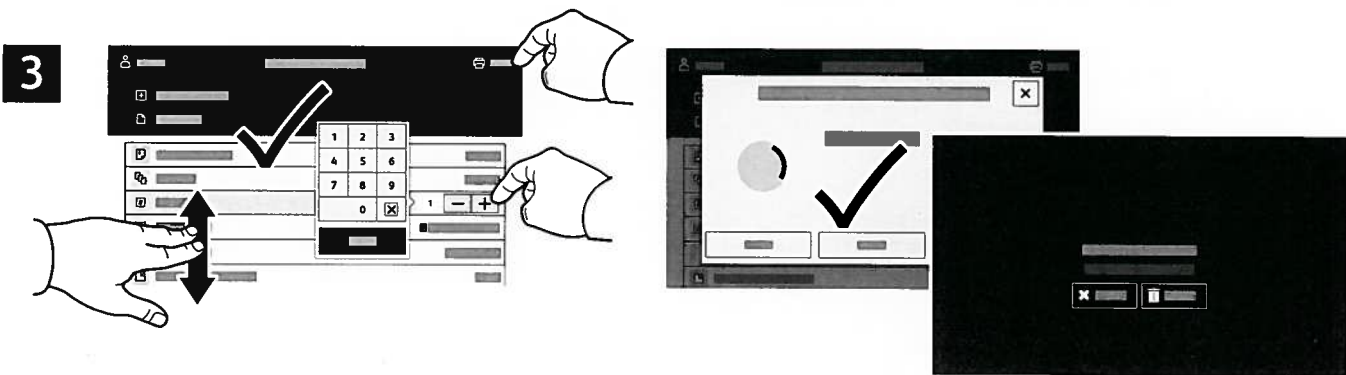

Select settings from the list. To select the number of copies, touch the plus sign (+) or the minus sign (-). For larger numbers, touch **Quantity** then enter a number. Touch **Print**. To delete the job, in the printing screen and confirmation screen, touch **Delete**.