

Χρήση αναλώσιμων

Αναλώσιμα

1 Κασέτες γραφίτη

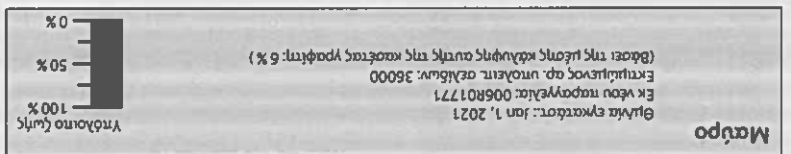

Στοιχεία προγραμματισμένης συντήρησης

2 Φύσιγγα τυμπάνου

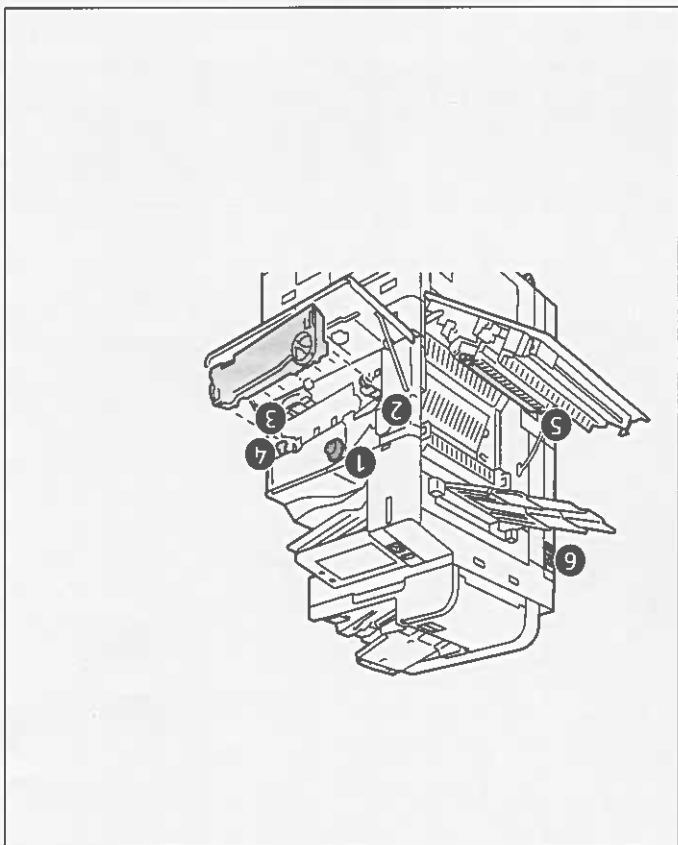
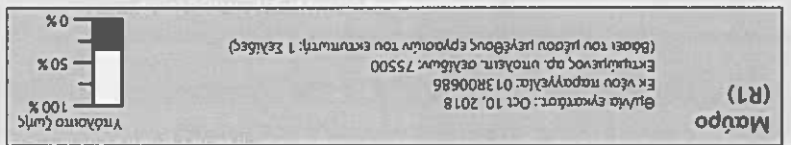

Πληροφο. παραγγ. αναλώσιμων στη www.xerox.com/office/supplies



Γιαννης

Αναλώσιμα

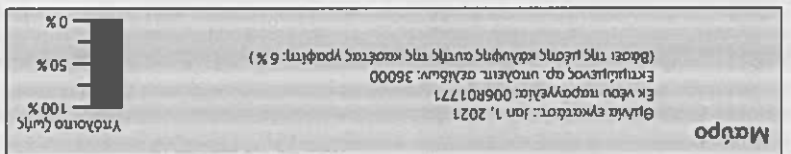

1 Κασέτες γραφίτη



Στοιχεία προγραμματισμένης συντήρησης

2 Φύσιγγα τυμπάνου

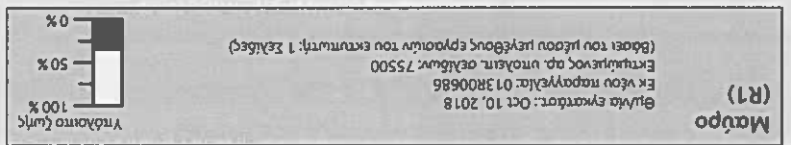

3 Περιέκτης υπολειμμάτων

Θηρία εγκατάστ.: Unknown
 Εξέλιξη παραγγελίας: 008R08101

OK

4 Σύστημα καθαρισμού ιμάντα μεταφοράς

Θηρία εγκατάστ.: Feb 9, 2024
 Εξέλιξη παραγγελίας: 001R00623
 Εκτιμώμενος αρ. υπολοίπ. σελίδων: 156500

5 Δευτερός κύλινδρος μεταφοράς φόρτισης

Θηρία εγκατάστ.: Feb 9, 2024
 Εξέλιξη παραγγελίας: 008R08103
 Εκτιμώμενος αρ. υπολοίπ. σελίδων: 356500

6 Φίλτρο ανεμιστήρα

Θηρία εγκατάστ.: Unknown
 Εξέλιξη παραγγελίας: Unknown
 Εκτιμώμενος αρ. υπολοίπ. σελίδων: 0

Romanian

Utilizare consumabile

Informațiile pentru comenziile de consumabile se află la www.xerox.com/office/supplies

Consumabile



1 Cartuș cu toner

Negru

Data instalării: Jan 1, 2021
 Comandă: 006R01771
 Nr. estimat de pagini rămase: 36000
 (La acoperire medie realizată cu acest cartuș cu toner: 6%)

Viață rămasă
100%
50%
0%

Articole pentru întreținere curentă

2 Cartuș cilindru



Negru (R1)

Data instalării: Oct 10, 2018
 Comandă: 013R00686
 Nr. estimat de pagini rămase: 75500
 (Cu lucrări de imprimare de dimensiune medie: 1 Pagini)

Viață rămasă
100%
50%
0%

3 Recipient pentru reziduuri



Data instalării: Unknown
Comandă: 008R08101

OK

4 Dispozitivul de curățare a benzii de transfer

Data instalării: Feb 9, 2024
Comandă: 001R00623
Nr. estimat de pagini rămase: 156500

Viață rămasă
100%
50%
0%



5 Rolă de transfer

Data instalării: Feb 9, 2024
Comandă: 008R08103
Nr. estimat de pagini rămase: 356500

Viață rămasă
100%
50%
0%



6 Filtru de ventilator

Data instalării: Unknown
Comandă:
Nr. estimat de pagini rămase: 0

Viață rămasă
100%
50%
0%

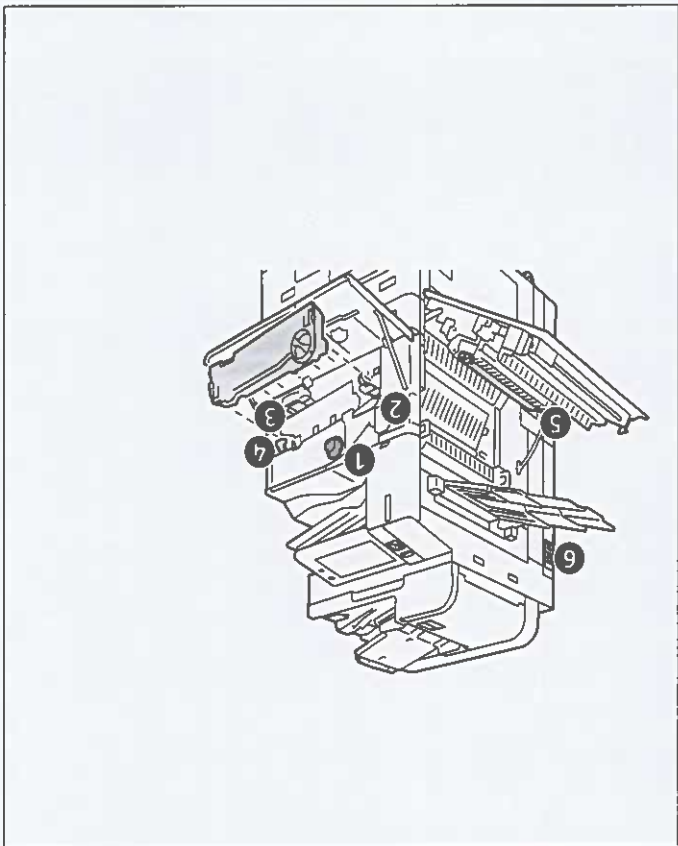

Čech 7692

Využití spotřebního materiálu

Informace o objednání spotřebního materiálu naleznete na adrese www.xerox.com/office/supplies

Spotřební materiál

1 Kazety s tonerem

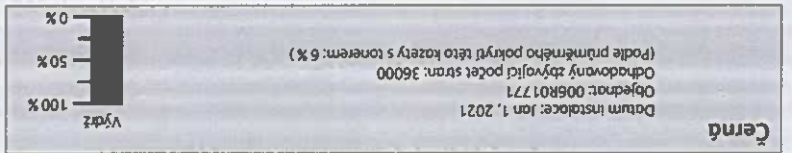

Položky běžné údržby

2 Tisková jednotka

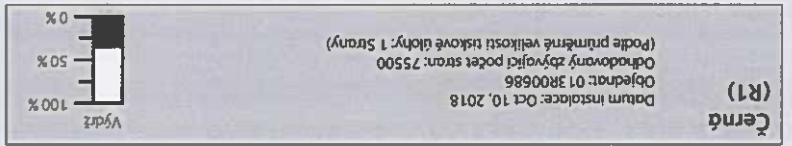

3 Odpadní nádobka



OK
Datum instalace: Unknown
Objednat: 008R08101

4 Čistič přenosového pásu

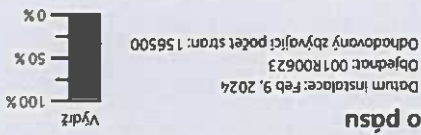

5 Druhý přenosový válec

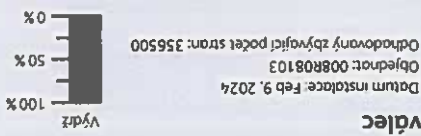

6 Filtr větráku

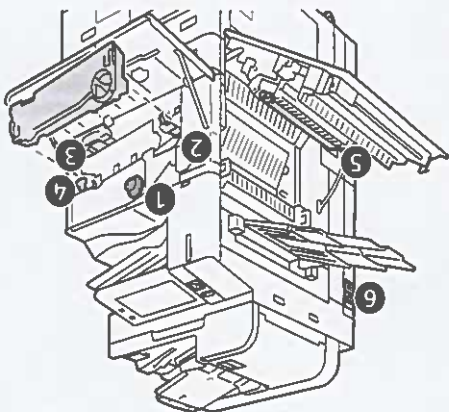

Sarf Malzemesi Kullanımı

Sarf Malzemeleri

1 Toner Kartuşları

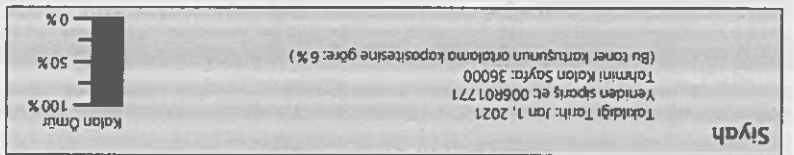

Rutin Bakım Öğeleri

2 Tambur Kartuşu

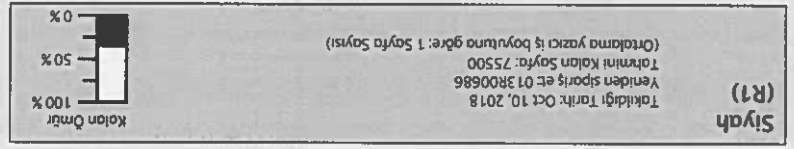

3 Atık Kabı



Takıldığı Tarih: Unknown
Yeniden sipariş et: 008R08101

Tamam

4 Aktarım Şeridi Temizleyicisi



Takıldığı Tarih: Feb 9, 2024
Yeniden sipariş et: 001R00623
Tahmini Kalan Sayfa: 156500

Kalan Ömür

0%
50%
100%

5 İkinci Eğilimli Aktarım Silindiri



Takıldığı Tarih: Feb 9, 2024
Yeniden sipariş et: 008R08103
Tahmini Kalan Sayfa: 356500

Kalan Ömür

0%
50%
100%

6 Fan Filtresi

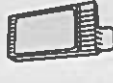

Takıldığı Tarih: Unknown
Yeniden sipariş et:
Tahmini Kalan Sayfa: 0

Kalan Ömür

0%
50%
100%

