

# Supplies Usage

## Consumables

1 Toner Cartridge

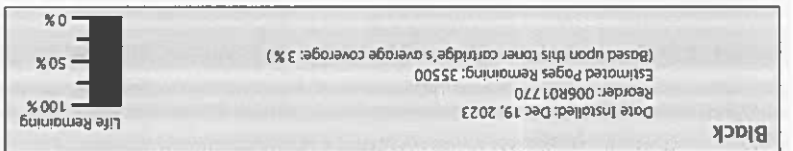

## Routine Maintenance Items

2 Drum Cartridge

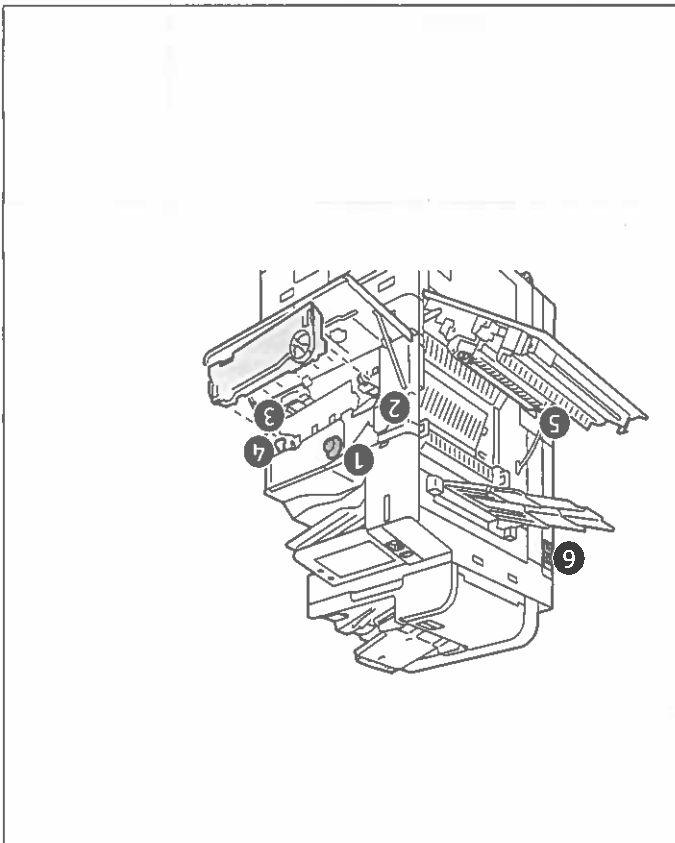
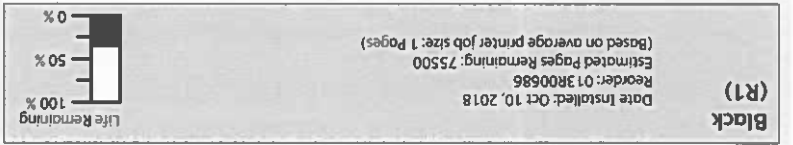
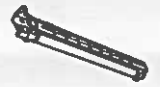

3 Waste Container



Date Installed: Unknown  
 Reorder: 008R08101

OK

4 Transfer Belt Cleaner



Date Installed: Feb 9, 2024  
 Reorder: 001R00623  
 Estimated Pages Remaining: 157000

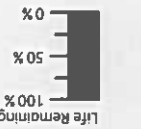

5 Second Bias Transfer Roller



Date Installed: Feb 9, 2024  
 Reorder: 008R08103  
 Estimated Pages Remaining: 357000



6 Fan Filter

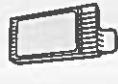

Date Installed: Unknown  
 Reorder:  
 Estimated Pages Remaining: 0

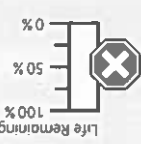

Supplies ordering information is located at [www.xerox.com/office/supplies](http://www.xerox.com/office/supplies)